

Design Project in year 2008/2009: PLC control of Mixing Process

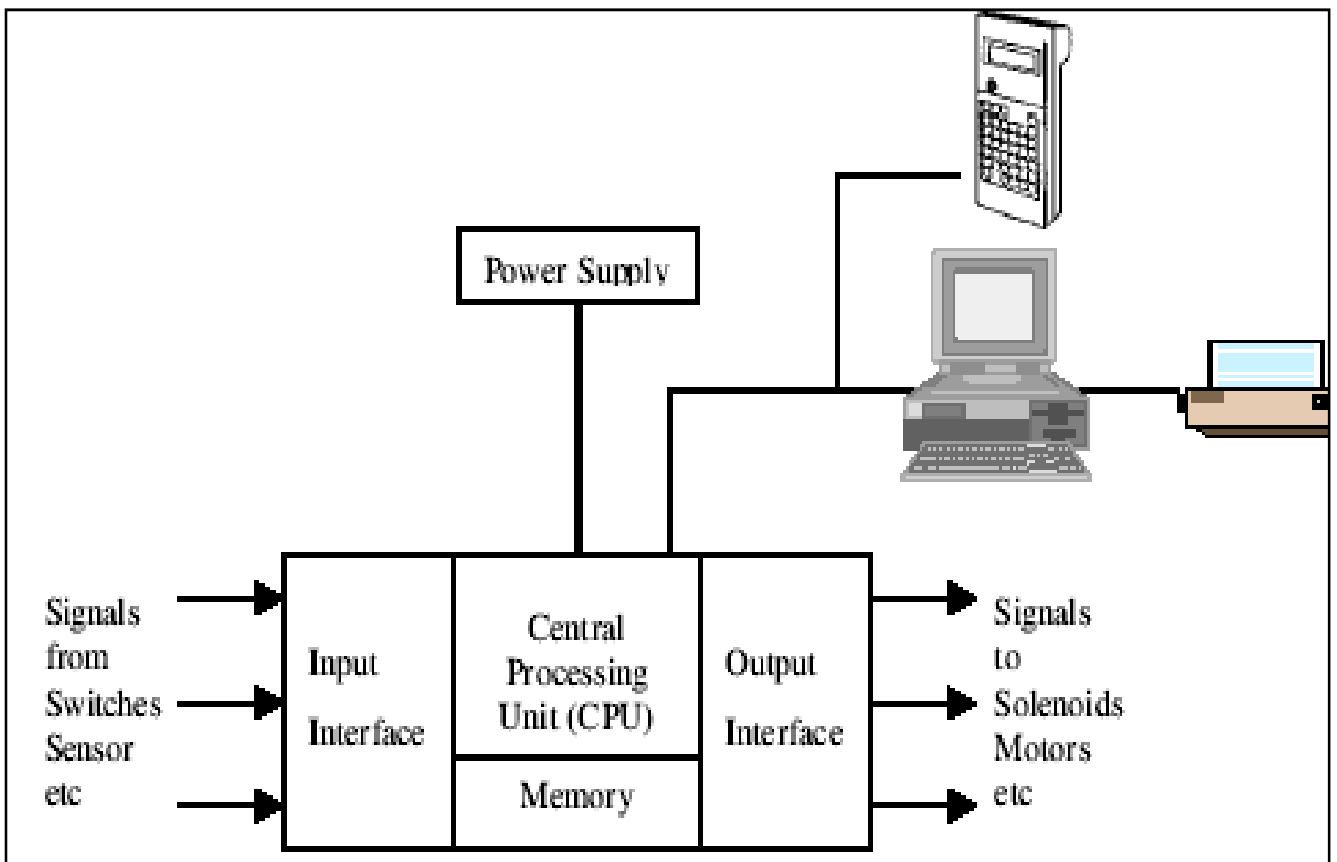

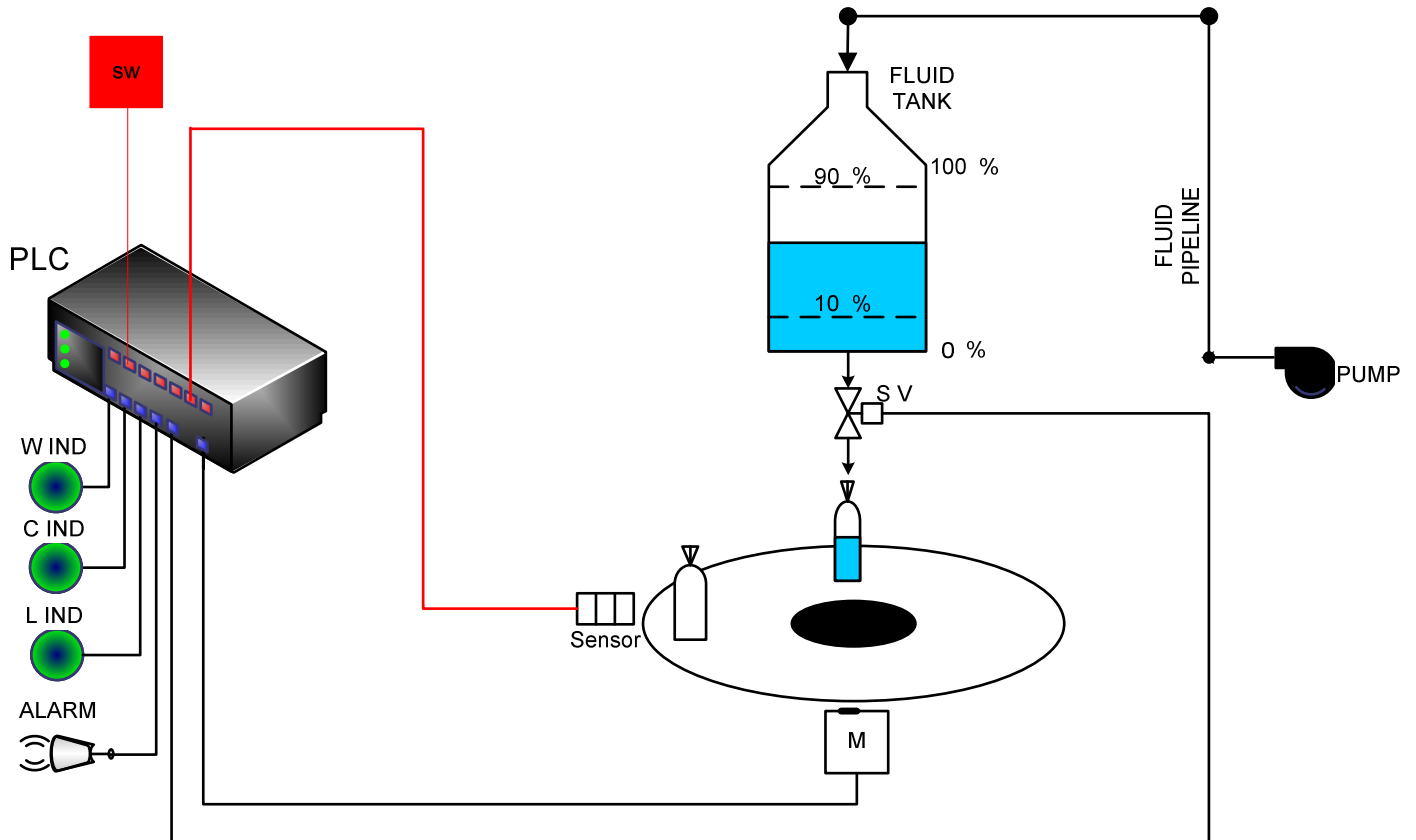

12 mm
Shielded

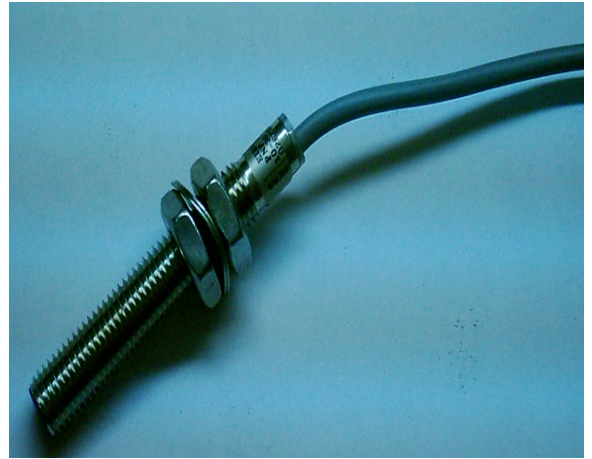
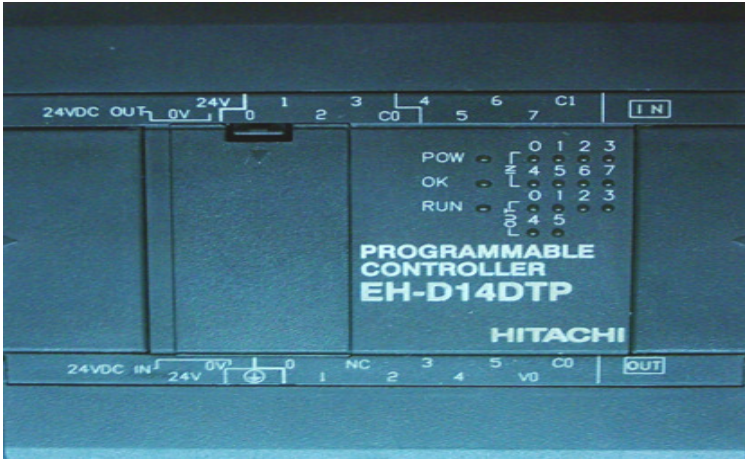
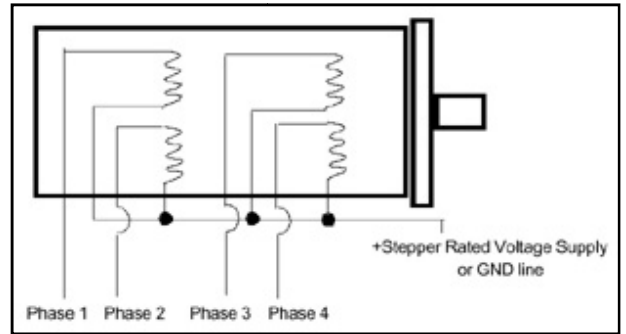
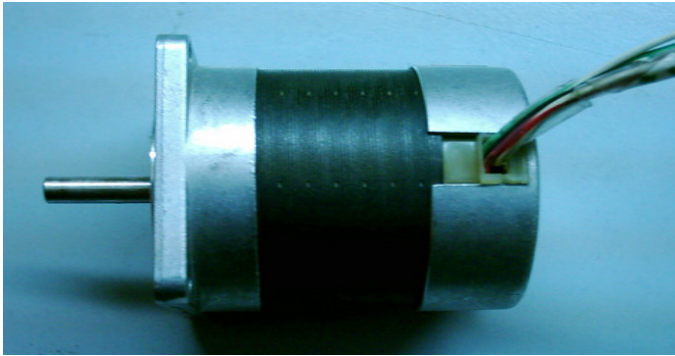
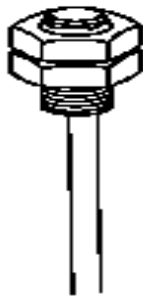

18 mm
Shorty



16 mm
Unshielded

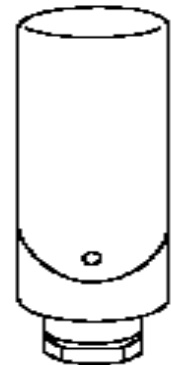

30 mm
Smooth Barrel

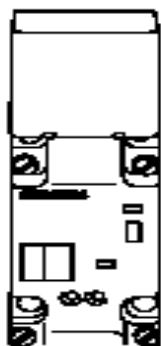

Limit Switch Style
Proximity Switch

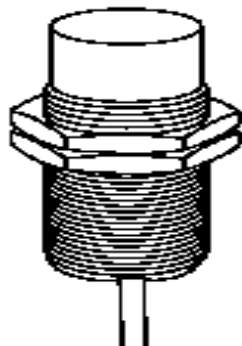

30 mm
Unshielded

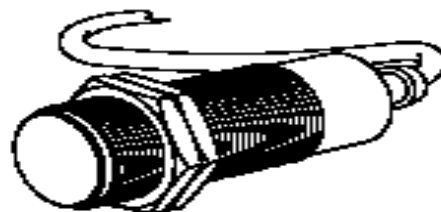

30 mm
Shielded



8 x 6 mm
Block